

超轻大卡尺

S_Cal UL

描述

- 最大移动速度: 1.5 m/sec
- 内外尺寸测量
- 完美的导向及防震系统
- 上下公差显示
- 超轻设计

移动测爪
(1m以上型号)

钨钢内尺寸测针 \varnothing 5 mm

8.5mmLCD显示

中空铝制尺身由两根
不锈钢柱加固，防水设计



内外尺寸测量均可
保持恒定测力

3m = 3kg

不锈钢外测爪，厚度7mm，
表面镀钛处理

OPTO

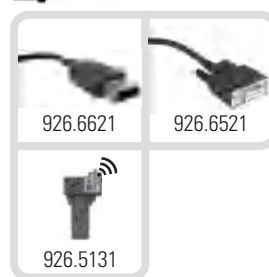

926.6621

926.6521

926.5131





超轻大卡尺

S_Cal UL

图纸尺寸

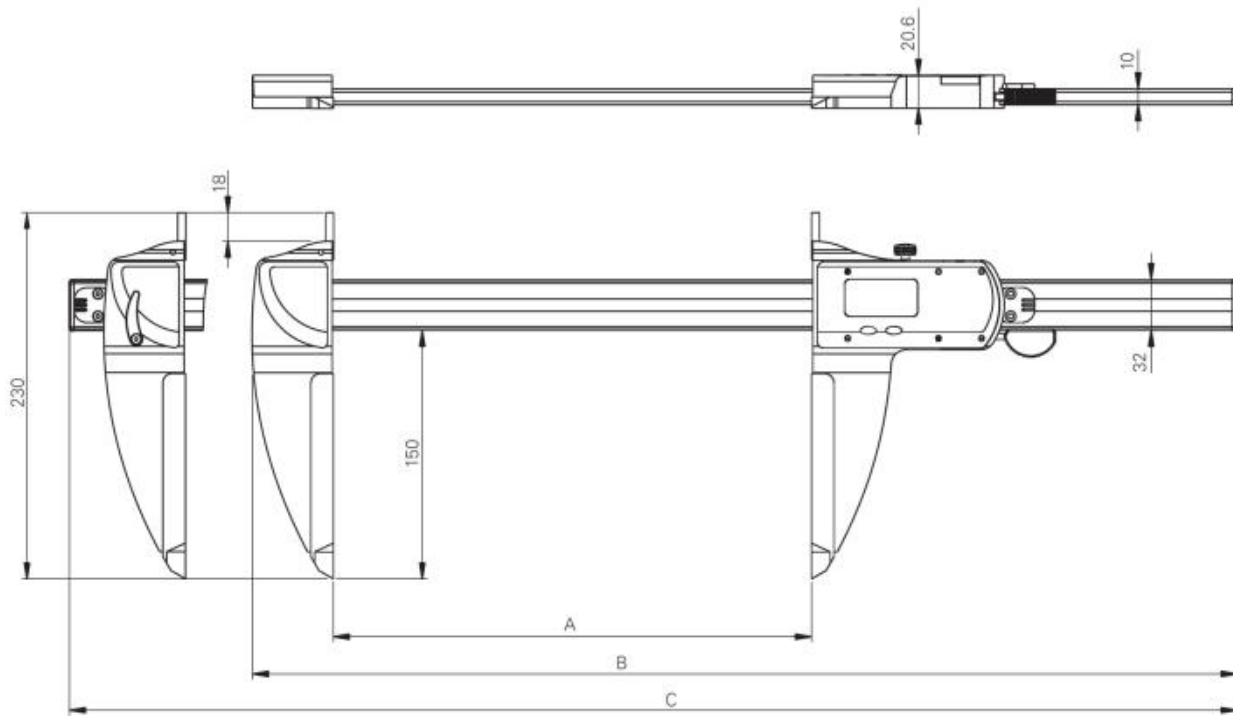

技术参数

| | | 911.1403 | 911.1406 | 911.1410 | 911.1415 | 911.1420 | 911.1425 | 911.1430 |
|-----------------|--------------------------------------|------------------|------------------|------------------|------------------|------------------|------------------|------------------|
| 测量范围 | mm | 300 | 600 | 1000 | 1500 | 2000 | 2500 | 3000 |
| 最大允许误差 | μm | 30 | 40 | 60 | 120 | 150 | 200 | 250 |
| 重复性 | μm | 20 | 20 | 20 | 20 | 30 | 30 | 30 |
| A | mm | 330 | 630 | 1025 | 1525 | 2040 | 2545 | 3050 |
| B 固定式 | mm | 618 | 918 | 1) ¹⁾ | 1) ¹⁾ | 1) ¹⁾ | 1) ¹⁾ | 1) ¹⁾ |
| C 移动式 | mm | 1) ¹⁾ | 1) ¹⁾ | 1306 | 1806 | 2306 | 2806 | 3306 |
| 重量 | kg | 1.1 | 1.3 | 1.6 | 2 | 2.3 | 2.6 | 3 |
| 数据接口: 光电 (Opto) | USB / RS232 / Wireless ²⁾ | | | | | | | |
| 电脑软件设置参数 | ● | | | | | | | |
| 设置记忆功能 | ● | | | | | | | |
| 两个参考基准设定 | ● | | | | | | | |
| 复位功能 | ● | | | | | | | |
| 最大/最小值功能 | ● | | | | | | | |
| 公差提示功能 | ● | | | | | | | |

¹⁾ 定制

²⁾ 参考数据线部分



超轻大卡尺

S_Cal UL

特殊应用 | 特殊测爪型号 A

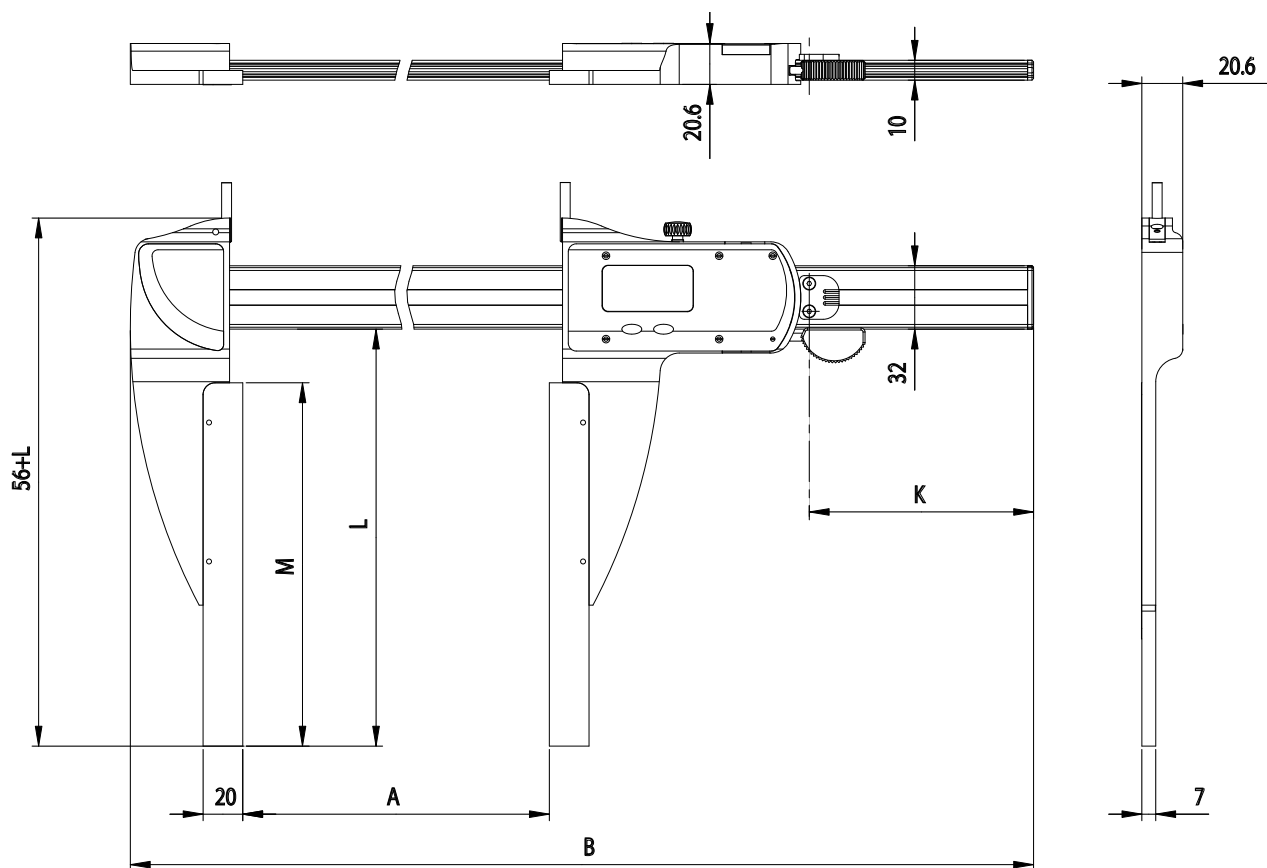

技术参数

| | | 911.2315.99 | 911.2316.99 | 911.2317.99 |
|-----------|----|-----------------------|-------------|-------------|
| 特殊测爪: (对) | | 长度根据订单确定: (最长 400 mm) | | |
| L | mm | ≤ 200 | ≤ 300 | ≤ 400 |
| M | mm | L - 25 | | |

| | | UL 300 | UL 600 | UL 1000 | UL 1500 | UL 2000 | UL 2500 | UL 3000 |
|-----------------|----|------------------------|----------|----------|----------|----------|----------|----------|
| UL 技术指标 | | 最大允许误差 [μm] / 重复性 [μm] | | | | | | |
| 配测爪 911.2315.99 | | 40 / 20 | 50 / 20 | 70 / 20 | 130 / 20 | 170 / 30 | 210 / 30 | 300 / 40 |
| 配测爪 911.2316.99 | | 50 / 30 | 60 / 30 | 90 / 30 | 150 / 30 | 200 / 40 | 300 / 40 | 400 / 50 |
| 配测爪 911.2317.99 | | 80 / 40 | 100 / 40 | 150 / 40 | 280 / 50 | 350 / 60 | 500 / 80 | - |
| A | mm | 320 | 602 | 1020 | 1530 | 2040 | 2520 | 3020 |
| B | mm | 618 | 918 | 1318 | 1818 | 2318 | 2818 | 3318 |
| K | mm | 110 | | 90 | | 110 | | |



超轻大卡尺

S_Cal UL

特殊应用 | 特殊测爪型号 C

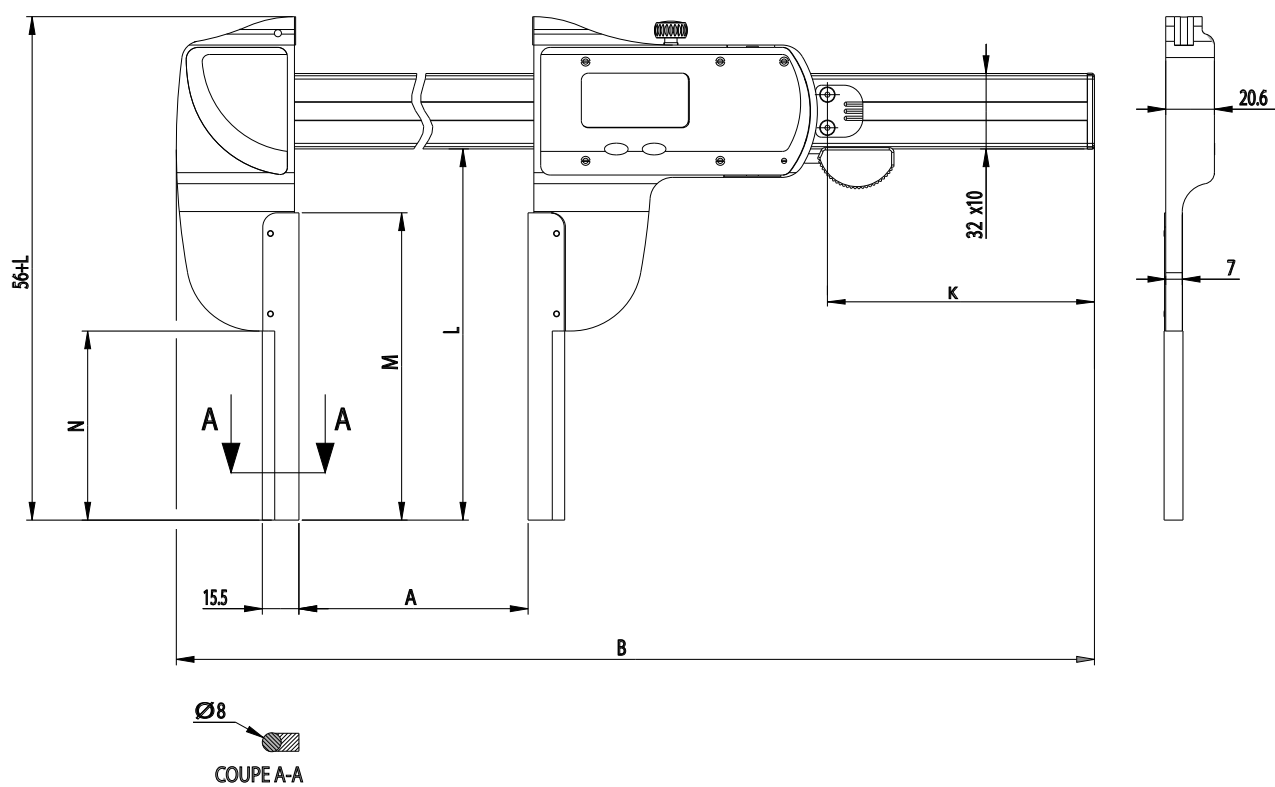

技术参数

| | | 911.2319.99 |
|-----------|----|--|
| 特殊测爪: (对) | | 长度根据订单确定: (最长 300 mm) |
| L max | mm | 300 |
| M | mm | L - 25 |
| N | mm | 80 |
| // | µm | ≤ 150 mm = 60 / ≤ 200 mm = 80 / ≤ 300 mm = 100 |

| | | UL 300 | UL 600 | UL 1000 | UL 1500 | UL 2000 | UL 2500 | UL 3000 |
|----------------|----|------------------------|---------|---------|----------|----------|----------|----------|
| UL 技术指标 | | 最大允许误差 [µm] / 重复性 [µm] | | | | | | |
| 配测爪 ≤ 150 | mm | 30 / 20 | 40 / 20 | 60 / 20 | 120 / 20 | 150 / 30 | 200 / 30 | 300 / 30 |
| 配测爪 ≤ 200 | mm | 40 / 20 | 50 / 20 | 70 / 20 | 130 / 20 | 170 / 30 | 210 / 30 | 300 / 40 |
| 配测爪 ≤ 300 | mm | 50 / 30 | 60 / 30 | 90 / 30 | 150 / 30 | 200 / 40 | 300 / 40 | 400 / 50 |
| A | mm | 344 | 644 | 1044 | 1544 | 2044 | 2544 | 3044 |
| B | mm | 618 | 918 | 1318 | 1818 | 2318 | 2818 | 3318 |
| K | mm | 110 | | | | | | |

S_Cal UL

仪器配置

- 仪器主机
- 内置锂电池CR2032
- 操作手册
- 校准证书 (ULIII 1500mm以内)

应用

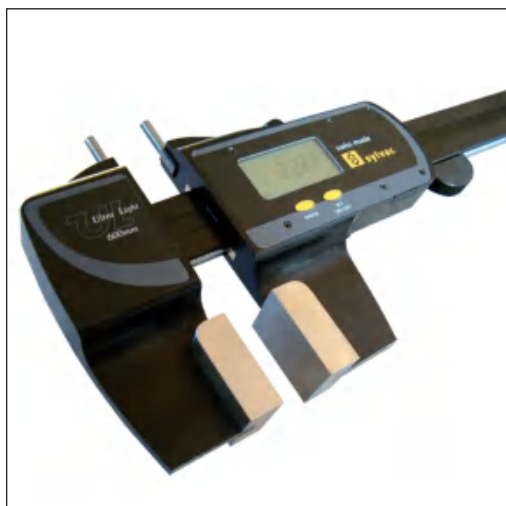

配置短测爪的特制超轻大卡尺



配置加长测爪的特制超轻大卡尺



S_Cal UL, 可移动左测爪



S_Cal UL

附件

UL300-3000

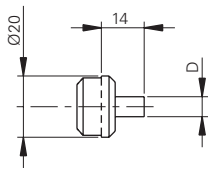

911.2301 Ø 6.35 mm 圆柱测头座用于挂载三针, (对)

●

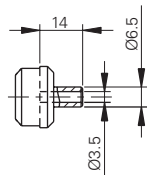

911.2302 同上 Ø 6.5 mm, (对)

●

911.2303 同上 Ø 8 mm, (对)

●

911.2304 螺纹测量座用于螺纹测量, (对)

●

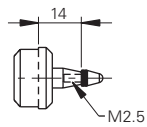

911.2305 带 M 2.5 螺纹孔的测头座 (对)

●

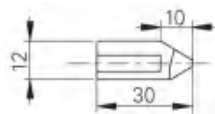

911.2307 钢制 60° 锥形测头, 用于中心距测量 > 10 mm, (对)

●

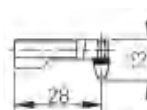

911.2308 带M2.5螺纹孔的测头座, 用于连接千分表的半球测头以测量内沟槽。(对)

●

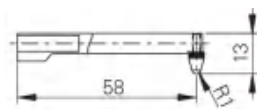

911.2309 同上, 高度58 mm, (对)

●

数据采集参考数据线部分

